

Natural Gas Installation Standards



2023 Handbook





Orville O. Cocking
Vice President
Operations

February 2023

Here at Orange and Rockland Utilities, Inc., our employees are dedicated to maintaining our company's long-standing reputation as a trusted provider of safe, reliable, clean, and cost-effective energy services and solutions. We strive to make the customer's experience the focus of all aspects of our daily operations.

The most important part of our mission is to provide a safe environment in which our employees and contractors can work, and for customers to safely enjoy the use of our electric and gas services.

In support of that mission, this Natural Gas Installations Standards Handbook (Yellow Book) was established by the company to communicate our standards for safe natural gas installations. The Yellow Book is to be followed in tandem with all applicable federal, state, and local regulations and codes governing safe natural gas installations.

To make your natural gas installation project go as smoothly as possible, be sure to submit your application for natural gas service to us at oru.com/ProjectCenter as early as possible in the planning process. Upon receipt of your application for service, you will be assigned a New Business Services Representative, who will work with you throughout this process.

We are here to help every step of the way. If you have any questions regarding this Yellow Book or your installation, our New Business Services Representative will be glad to assist you.

Stay safe,

Orville Cocking
Vice President, Operations

Natural Gas Installation Standards Handbook

These specifications will be revised or amended as required in keeping with developments and progress of the industry. The most recent published edition should always be referenced when making installation decisions regarding your gas service project. All previous editions are outdated and invalid. Additional copies of this document can be obtained at any of the Company's field offices listed below.

All applications for new, upgrade, and relocation of gas service will be coordinated through the following New Business Services Field Offices:

Blooming Grove

Route 208, Monroe, NY 10950

Phone 1 (845) 577-3324

Fax..... 1 (845) 783-5504

Middletown

71 Dolson Avenue, Middletown, NY 10940

Phone 1 (845) 577-3324

Fax..... 1 (845) 342-8939

Mahwah

One Lethbridge Plaza

Suite 32, Second Floor, Route 17 North, Mahwah, NJ 07430

Phone 1 (845) 577-3324

Fax..... 1 (201) 327-4521

Spring Valley Operations Center

390 West Route 59, Spring Valley, NY 10977

Phone 1 (845) 577-3324

Fax..... 1 (845) 577-3319

Call Before You Dig

“Be safe, call 811 now or you may be calling 911 later.”

If at any time you smell gas or suspect a gas leak, immediately call 911 or Orange & Rockland at

1-800-533-LEAK (5325)

For your safety and protection, the Utility Notification Service provides details on the location of underground electric wires, gas lines and communication cables, before you dig. This service is provided to reduce the risk of personal injury, prevent damage to underground facilities and avoid unnecessary repair costs and fines.

Before you dig, please call:

Underground Utilities Call Center of New York 811

NY Code 753 requires 2-10 working days notice.

Table of Contents

SECTION 1 Introduction	6
A. Purpose	6
B. Scope.....	6
C. Abbreviations.....	6
D. Definitions.....	7
SECTION 2 Governing Codes	9
SECTION 3 General Information	10
A. Application For Service:	10
B. Temporary Service:.....	11
C. Access to Customer Premises:	11
D. Meter and Equipment Ownership:	11
E. Customer Excavated Service Trenches:	11
SECTION 4 Gas Mains and Services.....	11
A. Gas Mains	11
B. Gas Service Lines.....	12
SECTION 5 Pressure Control Equipment	14
SECTION 6 Gas Meters	15
SECTION 7 Requirements for Gas Meter Installation	16
A. General Requirements:	16
B. Fuel Lines (piping beyond the gas meter):.....	17
C. Appliance Installation:.....	21
D. Venting:.....	22
E. Combustion Air:.....	23
F. Other Miscellaneous:	25
Appendix 1 – Gas Operations Standards.....	26
Appendix 2 – Distribution Excavation Agreement.....	26
Appendix 3 – Gas Meter Installation Standards	26
Appendix 4 – ANSI Z223. 1 Table II, Support Piping.....	26
Appendix 5 – Gas Meter Installation Checklist.....	26
Appendix 6 – Underground Fuel Piping Beyond the Meter Checklist.....	26

SPECIFICATIONS FOR GAS INSTALLATIONS

ORANGE AND ROCKLAND UTILITIES, INC.

SECTION 1 Introduction

A. Purpose

The information in this handbook provides a basic and uniform set of specifications and guidelines for the safe installation of gas service for the company's customers. The codes that are referenced and the information provided in no sense relieves the customer of the responsibility to install gas piping and appliances in accordance with the latest revisions of the applicable governing codes that are listed in Section 2. The customer should always feel free to consult a company representative regarding safe practices and practical applications of gas installation and equipment connection.

B. Scope

The information and specifications found in this handbook relate to the piping and equipment necessary for connecting the customer's appliances to the company's gas distribution system as well as other subjects of mutual interest to developers, customers, architects, engineers, and private contractors. This document is intended to be a guideline and is not a complete set of rules governing gas installations.

C. Abbreviations

AGA (IAS) American Gas Association (International Approval Services)
ANSI..... American National Standards Institute
BTU..... British Thermal Unit
BTUH British Thermal Unit per Hour
CCF Hundred Cubic Feet
CF Cubic Foot
CFH..... Cubic Foot per Hour
MBTUH Thousand British Thermal Units per Hour
MCF Thousand Cubic Feet
MMBTUH..... One Million British Thermal Units per Hour
PSIA..... Pounds per Square Inch Absolute
PSIG..... Pounds per Square Inch Gauge
UL Underwriters Laboratories
WC..... Pressure in Inches of Water Column

SPECIFICATIONS FOR GAS INSTALLATIONS

ORANGE AND ROCKLAND UTILITIES, INC.

D. Definitions

Appliance:

Any device that utilizes natural gas as a fuel or raw material to produce light, heat, power, steam, refrigeration or air conditioning.

British Thermal Unit (BTU):

The quantity of heat required to raise the temperature of one pound of water one degree Fahrenheit.

Building:

A structure that stands alone or is cut off from adjoining structures by firewalls, as defined by the municipality or the authority having jurisdiction, with no openings or penetrations and doorways to be protected by approved fire doors.

Combustible Material:

Any material such as wood, paper, sheet rock, fibers or other materials that will smolder, ignite or burn when adjacent to or in contact with heat producing appliances, vent connectors, gas vents, chimneys or hot water pipes.

Combustion Air:

Air supplied to an appliance specifically for the combustion of fuel.

Company:

Refers to Orange and Rockland Utilities, Inc. (O&R)

Cost or Expense:

All labor, material and other applicable charges including overheads involved with the work to be performed.

Cubic Foot of Gas (Standard):

The amount of gas that occupies one cubic foot of space when at a temperature of 60 degrees F, and under a pressure equivalent to that of 14.73 PSIA.

Customer:

A present customer or an applicant for the company's natural gas service.

Customer's Agent:

Architects, engineers, contractors, excavators, builders, and developers who are acting on behalf of a customer or applicant.

Direct Vent Appliance:

An appliance that is constructed and installed so that all air for combustion is obtained from the outside atmosphere and all flue gases are discharged to the outside atmosphere.

Excess Flow Valve (EFV):

A mechanical safety device installed on a gas service line that is designed to automatically shut off or restrict the flow of natural gas in the event the service line is damaged.

SPECIFICATIONS FOR GAS INSTALLATIONS

ORANGE AND ROCKLAND UTILITIES, INC.

Fan Assisted Appliance:

An appliance with a venting system designed to remove flue or vent gases by mechanical means, that may consist of an induced draft portion under negative static pressure or forced draft portion under positive static pressure.

Fire Wall:

A fire resistance rated wall having protected openings, which restricts the spread of fire and extends continuously from the foundation to or through the roof, with sufficient structural stability under fire conditions to allow collapse of construction on either side without collapse of the wall.

*Fire walls shall be in accordance with State and local building codes.

Fuel Line:

The piping that is installed after the company's meter or regulator that connects the customer's appliances and equipment to the gas supply. Fuel lines are the responsibility of the customer.

Gas Main or Main Extension:

The piping system owned by the company that is used for the distribution of gas that is (a) located within the limits of any public highway or on a private right of way or (b) used to supply gas to two or more gas services.

Gas Service:

The piping and accessory equipment owned by the company that is connected to the gas main and installed on a customer's property to supply gas to a residence or business.

Inches of Water Column:

A unit of pressure measurement (1PSI = 27.7 in WC).

Input Rating:

The gas burning capacity of an appliance in BTUH as specified by the manufacturer.

Loads Connected:

The sum of the rated BTUH input of all connected gas equipment. May also be expressed in cubic feet per hour.

Make Up Air:

The volume of outside air or inside air that is supplied to a space to replace air consumed by the gas burning appliances, exhausted or otherwise removed from the space.

Mechanical Exhaust Appliance:

An appliance with a venting system designed to remove flue or vent gases by mechanical means utilizing induced draft under negative pressure or forced draft under positive pressure.

Meter:

An instrument installed by the company to measure the volume of natural gas delivered to a customer.

SPECIFICATIONS FOR GAS INSTALLATIONS

ORANGE AND ROCKLAND UTILITIES, INC.

Primary Air:

The combustion air that mixes with the gas before it reaches the burner.

Qualified Installer:

An individual who is qualified by the company or an authority acceptable to the company.

Recommended:

Desired but not mandatory.

Regulator:

A device placed in a gas line for reducing, controlling and maintaining the natural gas pressure delivered to the customer.

Secondary Air:

The air externally supplied to the flame at the point of combustion.

Shall:

Mandatory in nature.

Shared Meter:

Any meter that measures service provided to a tenant's dwelling and also measures service to other space outside that dwelling. "Service to other space" includes service to equipment, such as space conditioning or water heating equipment, operated for the benefit of common areas of the building or other dwelling units.

Should:

Probable or expected.

SECTION 2 Governing Codes

Applicable codes are listed below. If there is a conflict of rules, the company will make a final decision applicable to the situation.

1. ANSI Z-223.1 / NFPA 54 National Fuel Gas Code

National Fire Protection Association

www.nfpa.org

2. New York Codes, Rules and Regulations (NYCRR)

Division of Administrative Rules – New York Department of State

www.dos.ny.gov/info/nycrr

3. Department of Transportation Title 49 CFR Part 192

Code of Federal Regulations

www.ecfr.gov

4. ANSI B31.8 Code of Pressure Piping

"Gas Transmission and Distribution Piping System"

American National Standards Institute

www.ansi.org

SPECIFICATIONS FOR GAS INSTALLATIONS

ORANGE AND ROCKLAND UTILITIES, INC.

5. Manual of Planning Standards for School Buildings

The New York State Education Department Facilities Planning
www.p12.nysed.gov/facplan/documents/MPS-2014.pdf

6. The New York State Fire Prevention and Building Code

Division of Code Enforcement and Administration
www.dos.ny.gov/dcea

SECTION 3 General Information

A. Application For Service:

Application for gas service can be made online at **oru.com/projectcenter**, by U.S. Mail Delivery or in person. The company requires an application form be submitted by the customer or its agent, denoting the rate class and type of natural gas service that is required by the customer. To ensure a timely service connection, it is necessary to consult the company regarding service availability before completing plans, purchasing equipment, and before any construction commences on a facility that is intended for connection to the company's gas distribution system.

In addition to the application for service, the customer is required to submit the following documents:

1. Three finalized plot plans, signed and sealed by a licensed land surveyor, consulting engineer or architect, showing the requested location of the gas service and gas meter location. The drawing shall include property lines, access roads, water, sewer, drainage, electric, telephone and cable television lines, in addition to showing the location of the building on the property. Please include any plans for future additions. Where the company determines that a meter(s) location(s) may be questionable with regard to safety or maintenance, a profile drawing will be requested showing the locations of windows, doors, vents and vehicular traffic areas.
2. A list of all natural gas equipment with the respective BTUH input and required pressure. This information may be provided either by separate letter, or on the company's application form.
3. The company provides gas pressure at 7 inches WC. Higher pressures will not be provided to compensate for inadequately-sized customer fuel lines. Exceptions to the 7 inches WC may be warranted for commercial or industrial customers who can demonstrate special fuel pressure needs, and where no other reasonable alternative exists.

NOTE: Higher delivered pressure requires advance approval of the company. In such cases, the applicant shall be required to provide written documentation on equipment specifications and fuel requirements.

SPECIFICATIONS FOR GAS INSTALLATIONS

ORANGE AND ROCKLAND UTILITIES, INC.

B. Temporary Service:

Natural gas service is not available for temporary services.

C. Access to Customer Premises:

Company employees or its agents shall have access, at all reasonable times, to read, install, repair, change, or inspect the company's gas meters, regulators, and the gas operated equipment installed on the customer's premises. To protect customers from unauthorized persons representing themselves as company employees, each employee has an identification card that will be shown upon request.

D. Meter and Equipment Ownership:

As the gas distribution company, Orange & Rockland owns and maintains all gas metering equipment regardless of the gas supplier.

E. Customer Excavated Service Trenches:

The company's gas crews, or its authorized contractors, normally excavate and install gas service on private property. To save on the cost of excavation, a customer may elect to dig and backfill the gas service trench. The company will install the gas service line in the customer's trench. A gas service trench shall be excavated to a minimum depth of 30 inches. The trench may contain electric, telecommunications and cable television cables, provided the required separation from the gas line is maintained. Reference Section 4 and Appendix 1 for gas service trench specifications.

SECTION 4 Gas Mains and Services

A. Gas Mains

a. General Information:

1. The gas main will be installed by the company or its agent.
2. No person, unless in the employ of the company, shall repair, alter, open, or make connections to, or do any work on any part of the company's gas supply system.
3. It is the customer's responsibility to notify the one call system, 811, and initiate a request to locate underground facilities prior to excavation and in accordance with the rules governing excavation in the state where the work will be performed. Excavation, construction, and demolition at or near underground facilities require strict adherence to state regulations. Requests for the location of underground facilities may not be made more than 10 working days prior to the start of the proposed work.

SPECIFICATIONS FOR GAS INSTALLATIONS

ORANGE AND ROCKLAND UTILITIES, INC.

b. Conditions for Installing Gas Facilities:

To provide prompt, safe and adequate gas supply to its customers, the company requires that the following conditions be met:

1. The customer shall provide the company with a completed application.
2. Site shall be graded to within six inches of final grade, and curbing and sidewalks, if required, shall be installed. Any relocation costs incurred after initial facility installation will be the responsibility of the customer.
3. The areas in which gas facilities are to be located shall be easily accessible and allow for good working conditions. Dirt piles, debris, construction material, etc. shall be removed from the gas route and trench. Trenches containing water shall be pumped out by the customer before installation of the pipe.
4. Stakes showing the center line and final elevation of roads or streets shall be installed and maintained by the customer, until construction is complete.
5. If required by the company, the customer shall execute and deliver to the company satisfactory written permanent easements or rights of way. Upon request, the company will provide the appropriate form for this purpose.
6. If the customer's agent elects to provide the common trench for electric, gas, telephone and cable facilities, this trenching shall be in accordance with Standard 261.1 found in Appendix 1 of this handbook, and shall comply with the agreement as set forth in Appendix 2 of this handbook.

B. Gas Service Lines

a. General Information:

1. The gas service will be installed by the company or its designated agent.
2. No person, unless in the employ of the company, shall repair, alter, open, or make connections to the service pipe or do any work on any parts of the company's gas supply system.
3. The company will install the gas service riser.
4. Metering equipment layout and service installations for commercial and industrial installations may vary. Company standards will be used as a guide in layout and installation (Refer to Appendix 3). Details of a particular installation will be provided by the company, upon request.
5. Gas service will be supplied to each building or premise through a single service pipe. Areas served by more than one service line shall be separated by an approved firewall.
6. The company's service line ends at the outlet of the customer meter or at the connection to a customer's piping, whichever is further downstream. The company reserves the right to specify the location of the gas service connection. The customer shall consult with the company's New Business Services representative regarding the location of the service connection prior to starting construction.

SPECIFICATIONS FOR GAS INSTALLATIONS

ORANGE AND ROCKLAND UTILITIES, INC.

7. Gas service lines shall be installed at a depth so as to have a minimum of twenty-four (24) inches of cover. Customer-provided trench shall conform to company standards found in Appendix 1. Sand or padding approved by the company shall be provided by the customer.

8. Service trenches shall generally run to the front of the building to be serviced, at the point closest to the main to which it will be connected. The gas service shall be installed perpendicular to the gas main, unless otherwise approved, in advance, by the company. Prior to installing gas service in a customer-provided trench, all other utilities (electric, CATV, telephone, etc.) shall be installed to allow for proper separation from the gas pipe. These utilities shall be in conduit or staked and padded to one side of the trench. There shall be no less than a 12 inch clearance between the gas service and the other utilities. If the electric is not in conduit, the electrical inspection shall be completed prior to gas installation to expedite backfilling operations. Refer to the Multi-Party Joint Trench Standard in Appendix 1C of this handbook.

b. Conditions for Installing Gas Service:

To provide prompt, safe and adequate gas service to its customers, the company requires that the following conditions be met by the customer or the customer's agent:

1. The areas in which gas services are located shall be easily accessible and allow for good working conditions. Dirt piles, debris, construction materials, etc. shall be removed from the gas route and service trench. Trenches containing water shall be pumped out by the customer before installation of the service pipe.
2. Building siding material shall be installed at the meter location prior to installation of the service, unless otherwise approved in writing by the company. Where non-traditional building materials prevent the mounting of gas service equipment directly to the building, the equipment shall be installed on a post and rack system. Refer to the Rotary Meter Free-Standing Support Installation Standard in Appendix 3 of this handbook.
3. Water mains and laterals, sewers and storm drains shall be installed prior to the installation of the gas service.
4. The route of the gas service and entrance to the building shall be at the closest point of supply, as approved by the company.
5. Final grade shall be indicated on the building at the gas service entrance.
6. Allow for the amount of time deemed necessary by the company to obtain the required road opening permit from the municipality to connect the gas service to its main.
7. Notify the company at least 10 working days in advance of the requested installation date, when all of the above requirements have been accomplished.
8. Where above ground gas piping is subject to vehicular damage, install and maintain adequate protection posts set in concrete as specified by the company

SPECIFICATIONS FOR GAS INSTALLATIONS

ORANGE AND ROCKLAND UTILITIES, INC.

(Refer to the Gas Meter Bollard Installation Standard in Appendix 3 of this handbook). **Note:** Service trenches should not be run to an area of the building which would subject any above ground gas piping to vehicular damage, unless such location is unavoidable.

9. After installation of the gas service, customer excavated trenches shall be backfilled, as soon as possible, with rock-free, company-approved material per the applicable standards in Appendix 1 of this handbook.

c. Retirement of Gas Service Lines

Where a building is to be demolished, in addition to complying with the rules governing excavations, local municipalities often require written verification of the disconnection and removal of gas facilities from the company, before they will issue a "Demolition Permit." A contractor planning to demolish a building shall contact Customer Service at 1-877-434-4100 at least 10 working days in advance of the demolition.

SECTION 5 Pressure Control Equipment

A service line to a customer includes equipment to reduce the pressure from distribution pressure to the pressure delivered to the customer. Such equipment is specifically sized to meet the customer's needs. The following provisions apply:

1. Delivered pressure greater than 7 inches WC may be allowed for commercial or industrial customers who can demonstrate that their appliance(s) need higher fuel pressure, and that no other reasonable alternative exists. Higher delivered pressure requires the prior approval of the company. In such cases, the customer shall provide written documentation on equipment specifications and fuel requirements. When higher pressure is delivered, the customer is responsible for providing pressure control equipment to reduce the gas pressure to any appliance that cannot operate at the higher pressure.
2. The company's pressure control equipment and meter will be located outside of the building, unless it is unsafe to do so in the judgment of the company.
3. Where piping may be subject to vehicular damage, pipe posts shall be placed and maintained by the customer around pressure control and metering equipment. This protection shall consist of a minimum of two (2) concrete-filled, three (3) inch or larger pipe posts or other suitable protection as determined by the company. The concrete posts shall be buried at least three (3) feet, and extend to a height of three (3) feet above ground. Post holes shall be filled with concrete. Refer to the Gas Meter Bollard Installation detail in Appendix 3 of this handbook.

NOTE: Certain installations may require more substantial protection at the discretion of the company (e.g. exposure to truck traffic).

CAUTION: Extreme care shall be taken during the installation of protective posts to avoid damage to the service line. Call 811 for the Underground Utilities Call Center to obtain a mark-out of gas and other buried utility services.

SPECIFICATIONS FOR GAS INSTALLATIONS

ORANGE AND ROCKLAND UTILITIES, INC.

4. Additional pressure control equipment installed by the customer to further reduce fuel line pressure shall have appropriate overpressure protection, if applicable. All such equipment shall be properly vented to outside atmosphere or have approved vent limiters installed. Common vent lines, if used, shall be properly sized. The vent terminus shall have an approved insect and water resistant cap and be installed a minimum of 18 inches from any building opening through which vented gas could enter the building, 10 feet from any forced air intake, and a minimum of 18 inches above grade.
5. The company regulator and meter installation shall be supported with brackets to the building wall.
6. Where necessary for safety, company-installed vent pipes may be routed above the roof line or to a safe location, and supported with brackets that are attached to the building wall.

SECTION 6 Gas Meters

The following requirements apply to gas meter installations:

1. The company will furnish and install all meters required for billing of gas delivered to the customer.
2. All meters shall be installed outside. The company reserves the right to designate or approve all meter locations. Gas meters shall not be installed:
 - a. Within three feet of sources of ignition including burners, electric panel boxes or machinery;
 - b. Unless there is 18 inches minimum separation from an electric meter;
 - c. Unless there is 10 ft minimum separation between the gas meter regulator and a transformer pad;
 - d. In areas that are not readily accessible for reading, replacement or necessary maintenance;
 - e. In areas deemed inconvenient or hazardous by the company.
3. Exceptions to the outside location of meters may be considered such as in urban commercial areas, or in other situations where physical conditions prohibit outside installation. Installation of a meter inside a building requires advance approval by the company prior to fuel line installation. If permission for an inside meter installation is granted, the meter shall be located as near as practical to the point of entry of the gas service in a well-ventilated area.
4. Meters are installed so that the meter inlet is on the left when reading the meter. Therefore, the customer shall install the fuel line on the right side of the meter.
5. Outlet Pipe size of residential meters:
METER SIZE /OUTLET PIPE SIZE (INCHES)
AC/AL 250 – 1 in, AL 425 – 1.25 in, AL 800 – 1.5 in

SPECIFICATIONS FOR GAS INSTALLATIONS

ORANGE AND ROCKLAND UTILITIES, INC.

NOTE: For meter sizes up through AL 800, the company will install a meter bar which serves as the connection point for the fuel line.

6. Sub-metering for the purpose of resale of natural gas is not permitted.
7. Only one gas meter is installed for each residential customer, unless otherwise determined necessary by the company.
8. For residential meter installations at apartments, condominiums, cooperatives and townhouses, as well as for certain commercial installations, gas meters are often “ganged” at a meter manifold at one location on the building. Allowance shall be made in the design of the building to provide adequate space to install multiple meters. In general, a minimum horizontal separation of 12 inches between meters shall be required. Where meter stacking is approved by the company, there shall be a vertical separation of two feet six inches, between rows. The number of rows shall not exceed three. The location shall be reviewed with, and approved by, a company representative prior to scheduling the installation. Fuel lines shall not penetrate the wall until the company has installed the manifold.
9. The company reserves the right to require the customer to provide:
 - a. Protective enclosures (typically a fence), if warranted by the physical conditions of the site
 - b. Concrete pad (for certain larger meter installations)
 - c. Free-standing support bracket, if not able to attach the company’s equipment to the building wall

When a fence is required, it shall be provided with a four-foot gate with locking hardware suitable for a padlock provided by the company. In lieu of the chain link fence, the customer may provide another form of suitable enclosure if approved by the company. The customer is responsible for keeping the area within the enclosure readily accessible and free from debris, weeds, brush, snow, etc.

Applicants should consult Appendix 3 for specific meter standards, which provide dimensional and physical details of standard installations. For further information, please contact your company representative.

10. Meters and associated equipment are sealed and/or locked to prevent tampering. Breaking of seals by unauthorized persons or tampering with meters or any associated piping is illegal. Violators will be subject to prosecution.

SECTION 7 Requirements for Gas Meter Installation

A. General Requirements:

1. The following requirements shall be completed by the customer prior to requesting meter installation and/or gas turn-on. This summary covers the most common, but not all, code compliance issues. The customer or persons performing natural gas installation work on behalf of the customer are responsible

SPECIFICATIONS FOR GAS INSTALLATIONS

ORANGE AND ROCKLAND UTILITIES, INC.

for satisfying all provisions of the appliance manufacturer's installation instructions and the applicable codes listed in Section 2 of this handbook. Please note that a service charge will be imposed for return trips to install meters that had no access, were not ready, or had code violations on the first visit.

2. Prior to requesting the gas meter, the customer or contractor shall complete the form entitled "Gas Certificate Form" located [online here](#). If the building is under new construction, contact the local code official from the municipality in which the work is being performed to schedule an inspection. No gas meters will be activated until a properly completed form is received by the company. Additional information on this process can be obtained by contacting your New Business Services Representative.

3. Electric meters are required to be set prior to installation of the gas meter unless otherwise approved, in advance, by the company.

4. Upon completion of the requirements listed herein, the customer should call the New Business Services Department to request installation of the gas meter. Phone numbers are listed on the inside front cover of this handbook.

5. Refer to Appendix 5 for the gas meter installation checklist.

B. Fuel Lines (piping beyond the gas meter):

1. For AL 250, AL 425 and AL 800 Class meter installations, when the inspection is satisfactorily completed and the meter is installed by the company, the meter will be left off but not locked. The customer's plumber will then be responsible for the lighting of appliances.

For rotary meter installations, the meter will be installed and locked when the service is installed. In such cases, the customer's plumber makes the final connection to the outlet of the meter or associated meter piping. Customer Service shall be contacted at 1-877-434-4100 when the customer is ready for a meter unlock.

2. For multiple meter installations:

a. Fuel lines shall not be extended through the building wall until the meter manifold is in place. When piping to a tiered manifold, care should be taken not to obstruct the area where the meters will be installed.

b. The customer's plumber shall permanently mark each meter bar with the unit or apartment number it serves and shall indicate the corresponding unit number in the service panel box within each unit or apartment. Gas meter bar markings shall match electric meter pan markings.

c. In order to avoid mixed or shared metering conditions in multi-unit buildings, units shall be identifiable by completed framing and electrical rough in and marked with the final unit number. To ensure the company's billing accurately reflects charges for the customer's own usage, it is critical that piping be installed and be traceable to the designated unit. Such will be verified by company personnel after the meter installation.

SPECIFICATIONS FOR GAS INSTALLATIONS

ORANGE AND ROCKLAND UTILITIES, INC.

- d. Heating of common areas such as hallways may not be supplied through the appliances connected to an individual tenant's meter.
3. All steel or malleable iron fuel lines shall be assembled using thread sealant suitable for natural gas. Sweated fittings are not permitted. Metallic press fittings (Viega MegaPress or equivalent) may be installed above grade, indoors and outdoors.
4. Underground piping, where installed below grade through the outer foundation or basement wall of a building, shall be encased in a protective pipe sleeve. The annular space between the gas piping and the sleeve shall be sealed. Above ground piping, where passing through an outside wall, shall be protected against corrosion by coating or wrapping with an inert material. Where piping is encased in a protective pipe sleeve, the annular space between the piping and the sleeve shall be sealed. Refer to Items 16 & 17 below for further details.
5. Fuel lines shall be supported or strapped, and shall be plumb and square. Refer to the Support Piping Table in Appendix 4.
6. Fuel lines on rooftops shall be supported and anchored to the roof.
7. Each appliance shall be provided with a shutoff valve separate from the appliance. The shutoff valve shall be located in the same room as the appliance, not further than 6 feet (1829 mm) from the appliance, and shall be installed upstream from the union, connector or quick disconnect device it serves. Such shutoff valves shall be accessible. Shutoff valves for vented decorative appliances and decorative appliances for installations in vented fireplaces may be installed in an area remote from the appliance, where such valves are provided with access. Such valves shall be permanently identified and shall serve no other equipment. Equipment shutoff valves located in the firebox of a fireplace shall be installed in accordance with the appliance manufacturer's instructions.
8. Water heaters, boilers and furnaces shall have drip legs and unions installed on the appliance side of the shutoff valve.
9. Concealed piping shall be black steel (schedule 40) or corrugated stainless steel tubing (CSST). CSST may only be installed by individuals trained and certified per code. Unions may not be concealed in ceilings, walls, floors or other partitions. CSST installations shall contain the required strike plates and approved termination fittings, and be bonded in accordance with manufacturer instructions and applicable codes.
10. Fuel lines and service lines are not permitted to be buried under buildings, slabs or other structures. If the customer plans to construct such a structure over a gas line, the line shall be relocated at the customer's expense.
11. Copper tubing within a building may only be used to connect a movable appliance such as a dryer, may only be located in the same room as the appliance, shall be joined by flared fittings (not sweated or compression), and may not be concealed in or pass through walls, ceilings, floors, cabinets or other partitions. Care shall be taken not to kink or damage copper tubing when moving appliances.

SPECIFICATIONS FOR GAS INSTALLATIONS

ORANGE AND ROCKLAND UTILITIES, INC.

12. Flexible connectors shall:
- a. Be AGA(IAS)-approved.
 - b. Only be used to connect a movable appliance such as a dryer or stove to the main fuel line (unless expressly approved in manufacturer's installation instructions).
 - c. Be stainless steel or plastic coated brass with the proper adapter ends.
 - d. Be located in the same room as the appliance.
 - e. Not pass through walls, floors, cabinets or other partitions.
 - f. Never be reused once removed from appliance.

NOTE: Care shall be taken not to damage flexible connectors when moving appliances.

13. Aluminum tubing is not permitted.

14. Stubbed out fuel lines to which appliances have not yet been connected shall have a valve installed and shall be capped or plugged.

15. Steel fuel lines operating at or above five psig or with a nominal diameter larger than four inches shall be welded.

16. All fuel lines shall be pressure tested for leakage. The following guidelines apply to above ground piping only. For buried lines see Item 17 below:

- a. Test pressure shall be measured with a manometer or with a pressure measuring device designed and calibrated to read, record, or indicate a pressure loss due to leakage during the test period. The source of pressure shall be isolated before the pressure test begins.
- b. The test pressure shall be three psig or 1.5 times the maximum operating pressure, whichever is greater.
- c. Test duration shall be no less than 1/2 hour for each 500 cubic feet of pipe volume or fraction thereof. When testing a system having a volume of less than 10 cubic feet or a system in a single family dwelling, the test duration may be reduced to 10 minutes.
- d. Written certification of fuel line tests shall be submitted by a licensed engineer to the company, where the municipality does not provide a certification form, for all large commercial and industrial installations. See the "Gas Certificate Form" [online here](#).

17. The following requirements apply to underground fuel lines installed by the customer (eg. pool heater or generator):

a. General:

Prior notification and a sketch of the proposed installation shall be provided to the company so that the service, regulator and meter capacity may be checked for the additional load. All materials including, but not limited to, pipe, couplings, transition fittings, risers and methods of joining shall be approved by the company.

SPECIFICATIONS FOR GAS INSTALLATIONS

ORANGE AND ROCKLAND UTILITIES, INC.

b. Trencher:

Trench bottom shall be level, free of rocks, and deep enough to provide a minimum of 24 inches cover above the pipe.

Sand padding with suitable rock-free material is required six inches below and six inches on top of the pipe.

Pipe in the trench shall not be in contact with or any closer than 12 inches to any other underground structure, cable, or pipe.

Customer-owned lines may not be installed within the public road nor within any railroad right of way.

Inspection by the company, prior to backfill, is also required.

Backfill material shall be free of rocks.

Warning mesh, available at company storerooms, shall be installed 12 inches above the service to warn and protect against excavation damage to buried gas facilities.

After installation, an as-built sketch shall be provided to the company for mapping purposes.

c. Future Fuel Line Repairs:

Any future repairs required on customer underground piping will be the sole responsibility of the customer.

d. Pressure Test of Underground Lines:

Up to and including two inch diameter shall be tested to 1 1/2 times maximum operating pressure or 40 psig, whichever is greater, for a minimum of 15 minutes. Above two inch diameter, duration shall be a minimum of 30 minutes. Maximum test pressure shall not exceed three times design pressure of the pipe and fittings.

e. Plastic Pipe:

1. Shall be high density polyethylene (HDPE).
2. Materials, fittings, and method of joining shall be approved by the company.
3. May only be installed outside underground by persons certified by the company.
4. Tracer wire shall be installed in the trench with the plastic pipe to facilitate future locating. The tracer wire shall be 12 AWG solid copper with HDPE (ASTM D-1248) insulation. The tracer wire shall be installed in the trench in close proximity to the pipe. However, the tracer wire shall not be wrapped around, taped to or touching the plastic pipe. The tracer wire shall be terminated above ground by wrapping around the steel riser pipes.
5. Steel risers used with plastic pipe shall be installed in accordance with the steel pipe specification below, except that a steel riser requires one, one-pound anode, unless an anodeless riser is utilized.

SPECIFICATIONS FOR GAS INSTALLATIONS

ORANGE AND ROCKLAND UTILITIES, INC.

6. A list of qualified plastic pipe installers will be provided by the company, upon request. However, the company does not endorse or recommend any installer and assumes no responsibility for prices, materials or workmanship of any installer.

f. Steel Pipe:

1. All steel surfaces in contact with soil shall be mill or field cleaned, primed and wrapped/coated with materials and methods approved by the company.
2. Approved fittings that electrically insulate buried steel from building piping shall be installed.
3. Magnesium anodes of the proper size and quantity shall be attached to all underground steel lines (one three pound anode for each 50 feet of pipe).
4. Galvanized pipe is not permitted.

g. Copper Tubing:

1. Approved fittings that electrically insulate copper tubing from the building piping shall be installed.
2. Shall be joined by flare or compression fittings. Sweated fittings are not permitted.
3. Is not required to be coated or wrapped.

h. CSST Pipe (flexible gas pipe):

1. All CSST piping shall be installed in accordance with State Fuel Gas Code.
2. Only qualified installers may install CSST pipe.
3. A gas piping system containing any CSST shall be directly bonded to the electrical service grounding electrode system. Bonding connections shall not be made through the electric service panel.
4. CSST cannot be buried directly underground or embedded in concrete. When buried underground, the tubing must be encased within a non-metallic, water-tight conduit having an inside diameter 1/2 inch larger than the outside diameter of the CSST tubing. The entry and exit ends of the conduit must be sealed or protected from the entry of water or contamination. No joints are permitted within the conduit; therefore venting of the conduit is not required.

C. Appliance Installation:

1. Appliance manufacturer's installation instructions shall be readily available on the job site for reference by company personnel and the customer.
2. All appliances shall be installed according to manufacturer's specifications and applicable codes.
3. At least one permanent piece of gas equipment shall be in place and properly installed, prior to installation of the gas meter.
4. Appliances, other than direct vent, shall not be installed in a bedroom.

SPECIFICATIONS FOR GAS INSTALLATIONS

ORANGE AND ROCKLAND UTILITIES, INC.

5. Requirements for decorative gas fireplaces/logs (other than direct vent/sealed combustion):
 - a. Shall be provided with combustion air from outside.
 - b. Shall have a permanently fixed open damper.
 - c. Shall not have a standing pilot light.
 - d. Shall have a safety to shut gas off automatically if the flame goes out.
 - e. Shall have tight fitting glass doors (solid or bifold with gaskets between panels)
 - f. Shall not be thermostatically controlled.
6. The burner portion of any appliance installed in a garage shall be at least 18 inches above the floor unless the appliance is designed with a flammable vapor barrier, and the appliance shall be protected from physical damage (ie: bollards).
7. Appliances shall be readily accessible for lighting and servicing, and shall be installed with front, rear and side clearances specified by the manufacturer.
8. The cold air return to a furnace shall not be from the same room in which the furnace is located. Cold air return duct joints and openings shall be air tight within the furnace room.
9. All appliances located on roofs or rooms that are 15 ft or above shall have a permanent inside access as defined by and in compliance with state building codes.

D. Venting:

1. Flues and chimneys that have previously burned a fuel other than natural gas shall be inspected for suitable physical condition and blockages and shall be cleaned before gas is utilized.
2. All vent systems shall be properly sized in accordance with the manufacturer's installation instructions. Be aware that vent systems which are too large are prohibited just as those which are too small.
3. Masonry Chimneys:
 - a. Flues shall be tight and cemented where they enter masonry chimneys.
 - b. Masonry chimneys shall have an approved and properly sized metal or clay tile liner.
 - c. Exterior masonry chimneys are not recommended and are prohibited for fan assisted appliances.
4. Metal Vent Systems:
 - a. Single wall pipe may only be used indoors in heated spaces to connect appliances to a chimney or common vent manifold within the same room as the appliance. Single wall may not pass through or be concealed in walls, floors or other partitions. Single wall requires a clearance of six inches from

SPECIFICATIONS FOR GAS INSTALLATIONS

ORANGE AND ROCKLAND UTILITIES, INC.

all combustibles including sheet rock. Single wall pipe shall be secured with sheet metal screws.

- b.** Metal vent systems passing through walls, floors, partitions or unheated spaces or installed outside shall, as a minimum, be double wall (type b) vent. Such systems installed outdoors shall be enclosed in a chase. It is recommended that manifolds for multiple common vented appliances be a minimum of double wall pipe.
- c.** Double wall pipe requires a clearance of one inch from combustibles, including sheetrock.

5. Plastic Vent Systems:

- a.** Materials, length, number of elbows and joining cement shall be as approved in, and conform strictly to, the manufacturer's installation instructions.
- b.** Shall be adequately supported.

6. Vent connectors shall slope upward from the appliance to the chimney (one quarter inch per foot).

7. For a gas appliance common vented with an oil appliance, the gas appliance vent shall enter the vertical chimney as close as possible and above the oil appliance vent.

8. Approved flange collars or thimbles shall be installed where chimneys pass through ceilings, walls and roofs.

9. Long horizontal runs of vent connector should be avoided by locating the appliance as close as possible to the vertical vent (maximum 1 1/2 ft per inch of pipe diameter).

10. Spill switches are required on all vented gas appliances.

11. Chimneys shall terminate the proper height above the roof line and have an approved cap installed (minimum three ft above the point it exits the roof and two ft above any structure within a 10 ft radius of the cap).

12. The proper draft diverter shall be installed if required. Barometric dampers shall be designed for natural gas (damper swings both ways).

13. Direct vent appliances shall terminate the proper distances from building openings and above the ground as specified in the manufacturer's installation instructions and applicable code. Such vents shall not terminate under grade-level decks.

E. Combustion Air:

- 1. Combustion air shall be provided for all natural gas appliances other than direct vent (sealed combustion).
- 2. Combustion air may not be taken from a bedroom or bathroom.
- 3. Combustion air requirements shall be calculated based upon the total

SPECIFICATIONS FOR GAS INSTALLATIONS

ORANGE AND ROCKLAND UTILITIES, INC.

btu/hr input of all appliances in the room and whether or not the room meets the definition of a confined space (room volume less than 50 cubic feet / 1,000 btu input. ex: 100,000 btu input requires a room volume of 5,000 cubic feet l x w x h — before additional air shall be introduced).

4. Combustion Air from Outdoors

a. Outdoor combustion air shall be provided through permanent openings (not windows) to the enclosure or by an engineered combustion air system. The minimum dimension of air openings shall not be less than three inches.

b. Permanent openings shall have a free area as specified for each method. Free area is defined as the cross-sectional area of the opening. Allow for reduction of free area based on the free area rating of the grill or louver.

- Example: A 24 inch by 12 inch opening has a free area of two square feet. Assume a grill with a free area of 50% is installed in the opening. Then the final free area is one square foot.

c. One Permanent Opening Method: Shall be located within 12 inches of the top of the enclosure. The opening shall communicate directly with the outdoors or through a vertical or horizontal duct to the outdoors. The opening shall have a minimum free area of 1 square inch per 3,000 Btu/h of the total input rating of all appliances located in the enclosure.

d. Two Permanent Openings Method: One opening located within 12 inches of the top of the enclosure and one opening located within 12 inches of the bottom of the enclosure. The openings shall communicate directly to the outdoors or through ducts to the outdoors. Each opening shall have a minimum free area of one square inch per 2,000 Btu/h of the total input rating of all appliances located in the enclosure.

e. Engineered combustion air systems shall provide an adequate supply of combustion, ventilation and dilution air, and shall be certified by a NYS licensed engineer.

5. Combustion Air from Indoor Spaces

a. One opening located within 12 inches of the top of the enclosure and one opening located within 12 inches of the bottom of the enclosure. Each opening shall have a minimum free area of one square inch per 1,000 Btu/h of the total input rating of all appliances located in the enclosure, but not less than 100 square inches. The minimum dimension of each opening shall not be less than 3 inches.

NOTE:

1. The volume of the room containing the appliances plus adjoining rooms supplying combustion air shall be large enough so as not to fall within the definition of a confined space (see above).

2. If the only appliance in the room is a clothes dryer, combustion air may be provided by a one inch undercut on the bottom of the door to the room.

3. Mechanical louvers and other types of powered combustion air or ventilation

SPECIFICATIONS FOR GAS INSTALLATIONS

ORANGE AND ROCKLAND UTILITIES, INC.

systems shall be interlocked with all appliances in the room such that when any appliance fires, the device(s) are activated. Conversely, if the devices do not activate, such as in a power failure, no appliances should be able to fire. All such devices shall be in place, wired and operational at the time of meter installation. Louver doors are not permitted by some municipalities; please check with the local Building Department.

F. Other Miscellaneous:

1. Industrial applications:

a. Customer-installed vent lines from controls shall be properly sized, piped to the outside, terminated no closer than 18 inches to building openings, terminated no less than 18 inches above the ground, terminated no closer than 10 feet to forced air intakes, and fitted with approved weather and insect resistant caps. For common venting of such lines, the equipment manufacturer shall be consulted on the proper sizing such that a failure of one piece of equipment does not cause another piece of equipment to operate unsafely. Vent limiters are acceptable in lieu of vent lines where specifically approved by the equipment manufacturer. Vent lines may not be run into flues or chimneys.

b. Customers receiving pressure in excess of 14 inches of water column are required to:

- 1.** Meet the requirements of NFPA 54, National Fuel Gas Code, including ANSI Z223.1, for pressure reducing equipment and piping;
- 2.** Contact the company for a safety review whenever a change in piping or appliances is planned;
- 3.** Have inspections performed as required by code.

2. Carbon Monoxide:

The company strongly recommends the installation of carbon monoxide detectors and offers the following suggestions:

- a.** Select a detector that carries the UL or IAS (AGA) seal of approval.
- b.** Install carbon monoxide detectors in accordance with applicable codes and manufacturer recommendations, including, but not limited to, sleeping quarters.
- c.** Replace batteries regularly, just as with smoke detectors.

NOTE: If the need arises to make repairs due to a carbon monoxide problem, make sure that the contractor hired has the necessary equipment to read carbon monoxide levels.

SPECIFICATIONS FOR GAS INSTALLATIONS

ORANGE AND ROCKLAND UTILITIES, INC.

Appendices

Appendix 1 – Gas Operations Standards

Gas Service Trench Standard 261. 0

Gas Main Trench Standard 261. 1

Appendix 2 – Distribution Excavation Agreement

Appendix 3 – Gas Meter Installation Standards

AL-250 Residential Meter Installation Standard 701

AL-425 Residential Meter Installation Standard 702

AL-800 Low Pressure Metered Installation Standard 703

15C-3M LP Rotary Meter Installation Standard 718

15C-3M HP Rotary Meter Installation Standard 719

5M LP Rotary Meter Installation Standard 720

5M HP Rotary Meter Installation Standard 721

7M LP Rotary Meter Installation Standard 724

7M HP Rotary Meter Installation Standard 726

Gas Meter Bollard Installation Standard 731

Rotary Meter Free-Standing Support Installation Standard 732

Appendix 4 – ANSI Z223. 1 Table II, Support Piping

Appendix 5 – Gas Meter Installation Checklist

Appendix 6 – Underground Fuel Piping Beyond the Meter Checklist

APPENDIX 1

GAS STANDARDS

GAS SERVICE TRENCH

Profile – Gas Service (gas only)

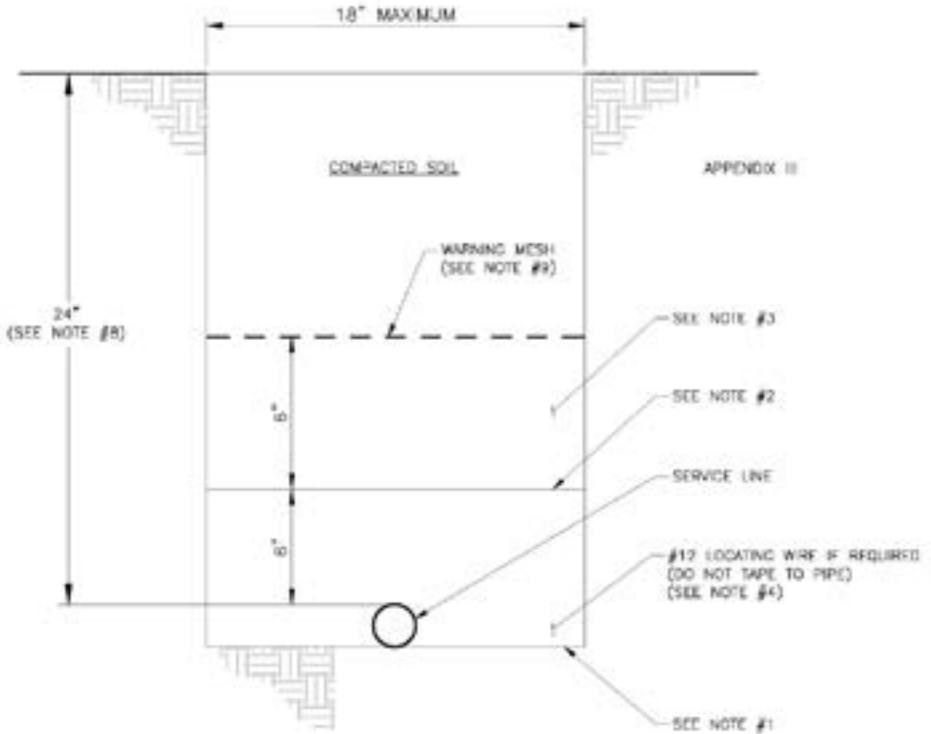

ORANGE AND ROCKLAND UTILITIES, INC.

DATE:
01/09/97

REVISION:
04/17/14

DEPT.
GAS OPERATIONS

APPROVED BY:

REFERENCE:

STANDARD NO.:

261.0-1

APPENDIX 1

GAS STANDARDS

GAS SERVICE TRENCH

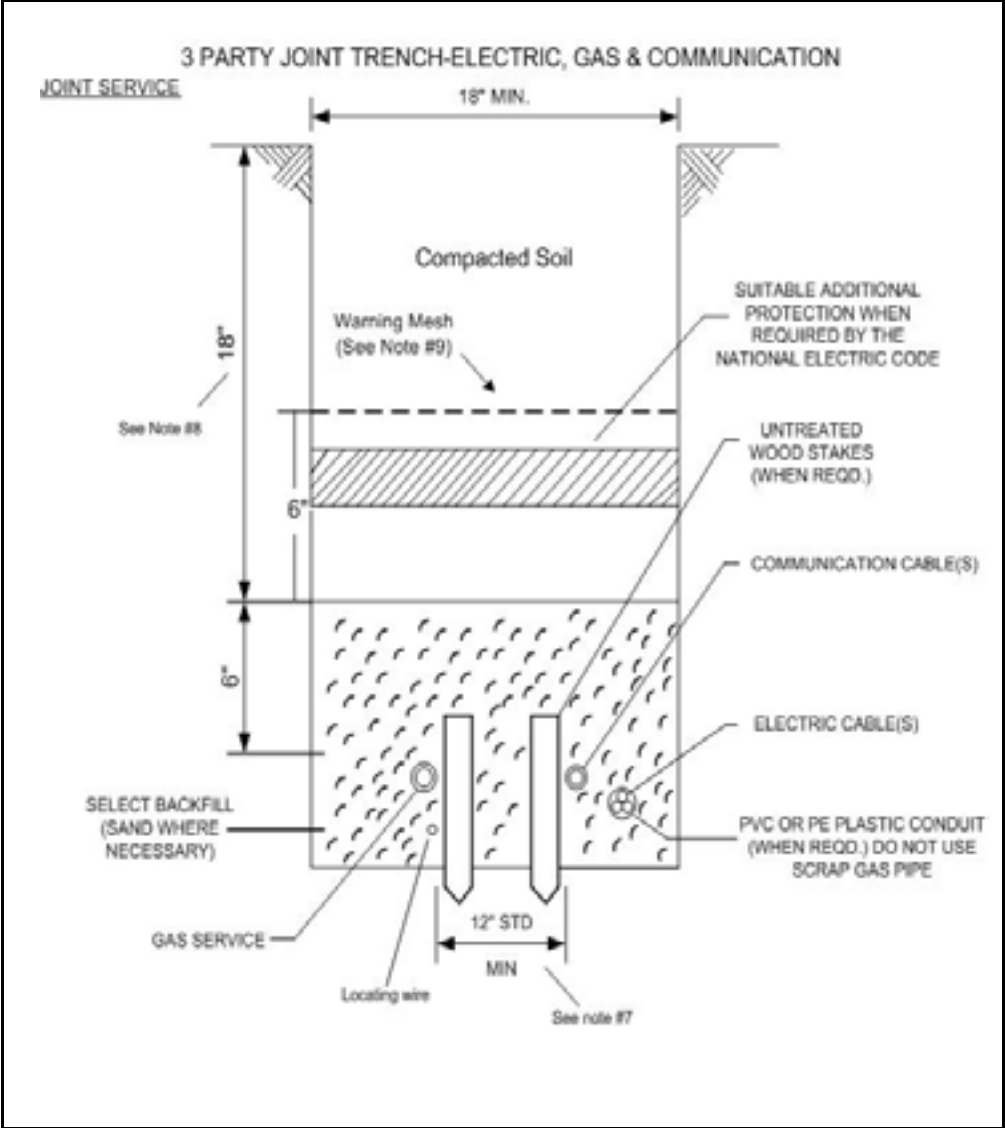

ORANGE AND ROCKLAND UTILITIES, INC.

DATE: 01/09/97	REVISION: 04/17/14	DEPT. GAS OPERATIONS
APPROVED BY: 	REFERENCE:	STANDARD NO.: <div style="text-align: center; font-size: 1.5em; font-weight: bold; margin-top: 10px;">261.0-2</div>

APPENDIX 1

GAS STANDARDS

GAS SERVICE TRENCH

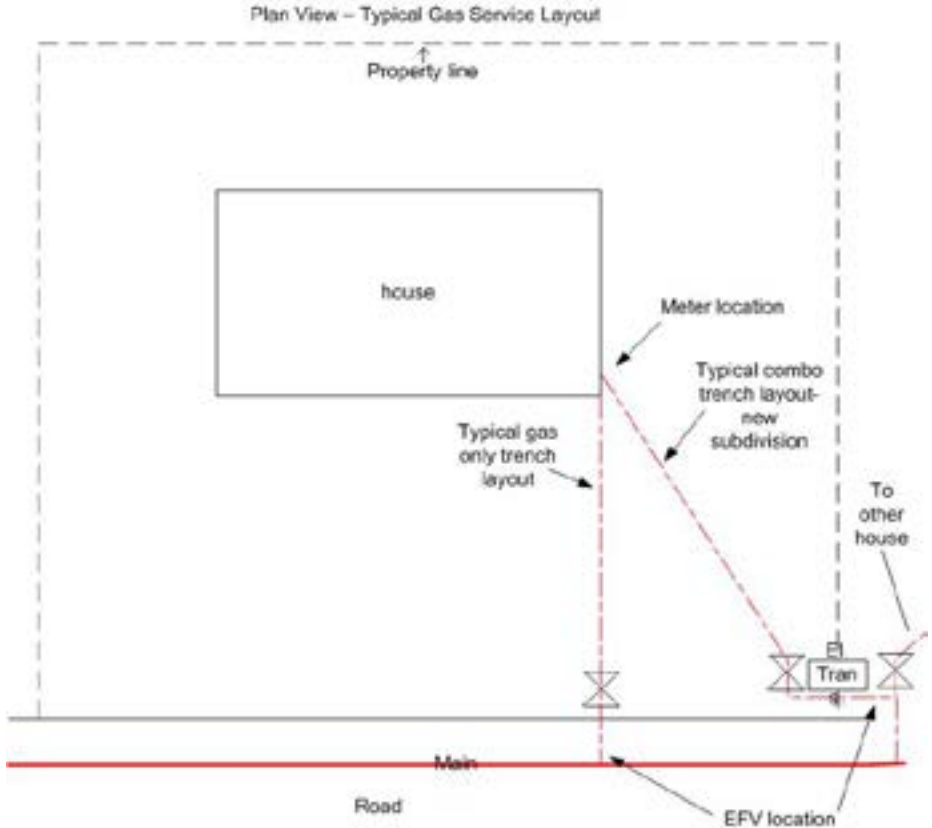

NOTES:

1. BOTTOM OF TRENCH SHALL BE FREE OF ROCKS AND OTHER DEBRIS.
2. HAND PAD AROUND SERVICE LINE WITH <SAND OR> SUITABLE ROCK-FREE MATERIAL < TO 6" ABOVE> AS REQUIRED.
3. THE MATERIAL USED FOR BACKFILLING SHALL BE FREE OF LARGE ROCKS AND ANY OTHER MATERIALS THAT MIGHT CAUSE DAMAGE TO THE PIPE. IF SUITABLE MATERIAL CANNOT BE FOUND, SAND WILL NEED TO BE BROUGHT TO THE SITE OR CONDUIT MAY BE USED. CONDUIT SHALL BE MARKED FOR GAS USE, OR AS A MINIMUM, HAVE NO MARKINGS. CONDUIT SHALL NOT BE USED WHEN MARKED FOR USE BY ANOTHER UTILITY.

ORANGE AND ROCKLAND UTILITIES, INC.

DATE: 01/09/97	REVISION: 04/17/14	DEPT. GAS OPERATIONS
APPROVED BY: 	REFERENCE:	STANDARD NO.: 261.0-3

APPENDIX 1

GAS STANDARDS

GAS SERVICE TRENCH

4. <LOCATING WIRE SHALL BE INSTALLED IN CLOSE PROXIMITY TO THE PIPE, BUT NOT TAPED TO OR WRAPPED AROUND THE PIPE, AND CONTACT WITH THE PIPE SHALL BE MINIMIZED. > LOCATING WIRE SHALL BE TERMINATED AT TOP OF GAS SERVICE RISER AND AT MAIN LOCATING WIRE. CONNECTION AT MAIN LOCATING WIRE SHALL BE WITH AN APPROVED CONNECTOR AND TAPED WITH AN APPROVED MATERIAL.
5. GAS ONLY SERVICE FEEDS SHOULD GENERALLY BE INSTALLED PERPENDICULAR TO THE GAS MAIN TO FACILITATE LOCATING OF THE SERVICE LINE.
6. THE SERVICE ENTRANCE LOCATION FOR A GAS ONLY SERVICE SHOULD GENERALLY BE ON THE FRONT OF THE HOUSE, BUT MAY BE INSTALLED ON THE SIDE OF THE HOUSE IF MUTUALLY AGREED UPON BY THE CUSTOMER AND THE COMPANY. INSTALLING THE METER ON THE REAR OF THE HOUSE IS GENERALLY UNACCEPTABLE.
7. <MAINTAIN FOUR INCHES VERTICAL CLEARANCE BETWEEN THE SERVICE PIPE AND ANY OTHER UTILITY OR SUBSURFACE STRUCTURE. WHERE THE GAS SERVICE CROSSES ANOTHER UTILITY, USE A SANDBAG BETWEEN THE GAS LINE AND THE OTHER UTILITY(S) TO ENSURE 4" CLEARANCE IS MAINTAINED. WHERE 4" VERTICAL CLEARANCE CANNOT BE MAINTAINED, A MINIMUM CLEARANCE OF 2" IS PERMISSIBLE IF PROTECTION IS PROVIDED, SUCH AS PVC OR PE CONDUIT, TO PREVENT DAMAGE DUE TO PROXIMITY OF OTHER STRUCTURE(S) AND THIS CONDUIT SHALL BE MAPPED. IN COMMON TRENCH INSTALLATIONS, 12" CLEARANCE BETWEEN PARALLEL GAS AND ELECTRIC FACILITIES TO MINIMIZE THE POTENTIAL IMPACT OF AN ELECTRIC BURN OUT ON THE GAS LINE. IF 12" HORIZONTAL CLEARANCE IS IMPRACTICAL, THE ABSOLUTE MINIMUM HORIZONTAL CLEARANCE SHALL BE 6" IF PROTECTION IS PROVIDED, SUCH AS PVC OR PE CONDUIT, TO PREVENT DAMAGE DUE TO PROXIMITY OF THESE STRUCTURE(S) AND THIS CONDUIT SHALL BE MAPPED.>
8. <THE GAS SERVICE SHOULD BE INSTALLED WITH 24" COVER AND BE AT LEAST 6" UNDER THE ROADBED. WHERE 18" COVER CANNOT MAINTAINED OR WHEN THE GAS SERVICE IS WITHIN 6" OF THE ROADBED, STEEL PROTECTION PLATES (MINIMUM 1/4" THICK) SHALL BE INSTALLED ABOVE THE GAS SERVICE (6" ABOVE, IF POSSIBLE) AND GAS ENGINEERING SHALL BE CONTACTED. THE PROTECTION PLATES/SHALLOW SERVICE SHALL BE MAPPED.>
9. <WARNING MESH, OR WARNING TAPE IF WARNING MESH IS NOT AVAILABLE, SHALL BE INSTALLED ABOVE THE GAS SERVICE, 12" ABOVE IF POSSIBLE.>
10. <FOR LOW PRESSURE SERVICES, WHERE CONDENSATE IN THE GAS MIGHT CAUSE INTERRUPTION IN THE GAS SUPPLY TO THE CUSTOMER, THE SERVICE LINE MUST BE GRADED SO AS TO DRAIN INTO THE MAIN.>

ORANGE AND ROCKLAND UTILITIES, INC.

DATE: 01/09/97	REVISION: 04/17/14	DEPT. GAS OPERATIONS
APPROVED BY: 	REFERENCE:	STANDARD NO.: 261.0-4

APPENDIX 1

GAS STANDARDS

GAS MAIN TRENCH

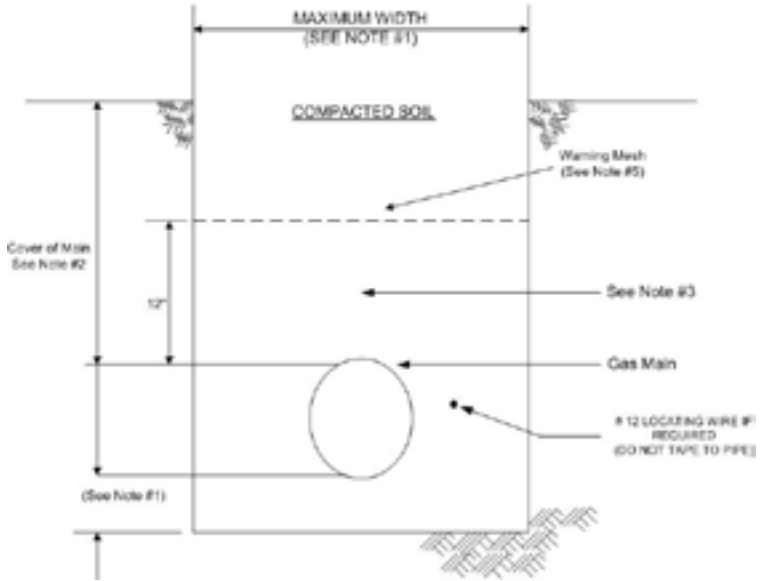

NOTES:

1. PIPE SIZE	MAX. WIDTH OF TRENCH	MIN. DEPTH OF PADDING UNDER MAIN (IF REQ.)
4" AND UNDER	18"	4"
6" TO 8"	24"	4"
10" TO 16"	36"	4"
OVER 16"	42"	4"

2. COVER OF MAIN:
 < 125 PSIG MAOP – 30" IN ALL TYPES OF SOIL (ENOUGH TO MAINTAIN 24" COVER ON SERVICES)
 >=125 PSIG MAOP – 36" IN ALL TYPES OF SOIL

 <ALSO, THE MAIN NEEDS TO BE INSTALLED AT LEAST 6" UNDER THE ROADBED. WHERE 24" COVER CANNOT BE MAINTAINED OR THE MAIN IS WITHIN 6" OF THE ROADBED, STEEL PLATES (MINIMUM 1/4" THICK) SHALL BE INSTALLED ABOVE THE MAIN (6" ABOVE, IF POSSIBLE) AND GAS ENGINEERING SHALL BE CONTACTED. THE PROTECTION PLATES/SHALLOW GAS FACILITIES SHALL BE MAPPED.>
3. HAND PAD APPROVED SAND AROUND MAIN, PROVIDING A MINIMUM OF 6" ABOVE MAIN.
4. THE MATERIAL USED FOR BACKFILLING SHALL BE FREE OF LARGE ROCKS OR ANY OTHER MATERIALS THAT MIGHT CAUSE DAMAGE TO PIPE OR COATING.
5. <WARNING MESH, OR WARNING TAPE IF WARNING MESH IS NOT AVAILABLE, SHALL BE INSTALLED ABOVE THE MAIN, 12" ABOVE IF POSSIBLE.>

ORANGE AND ROCKLAND UTILITIES, INC.

DATE: 02/05/97	REVISION: 04/17/14	DEPT. Gas Operations
APPROVED BY: 	REFERENCE:	STANDARD NO.: 261.1

DISTRIBUTION EXCAVATION AGREEMENT

DATE: ____ / ____ / ____

It is agreed between Orange and Rockland Utilities, Inc. (hereinafter referred to as Orange and Rockland) and _____ for the purpose of supplying distribution trench for Electric, Gas, Telephone and Cable facilities. (NOT TO INCLUDE SERVICE TRENCH). Applicant agrees to supply _____ feet of acceptable trench, sand padding and backfill within the confines of _____ and comply with all Utility Specifications (Attached) as well as all rules and regulations as required by Sate and Local building codes and laws.

Orange and Rockland shall pay Applicant at the rate of \$_____ per foot of trench for normal distribution trench excavation.

Orange and Rockland shall pay Applicant for rock excavation at the rate of \$_____ per cubic yard in addition to normal distribution trench excavation. Orange and Rockland will only pay for rock excavation when investigated and approved by an Orange and Rockland Representative during the actual removal of the rock.

Applicate shall submit formal invoices to Orange and Rockland, stating the location of the dig, dates, trench footage and total invoice amount.

Deviations from the original pan an layout will only be allowed when approved by an Orange and Rockland Representative.

APPLICANT

TITLE

ORANGE AND ROCKLAND UTILITIES, INC.

TITLE

APPENDIX 3

GAS STANDARDS

AL-250 RESIDENTIAL METER INSTALLATION

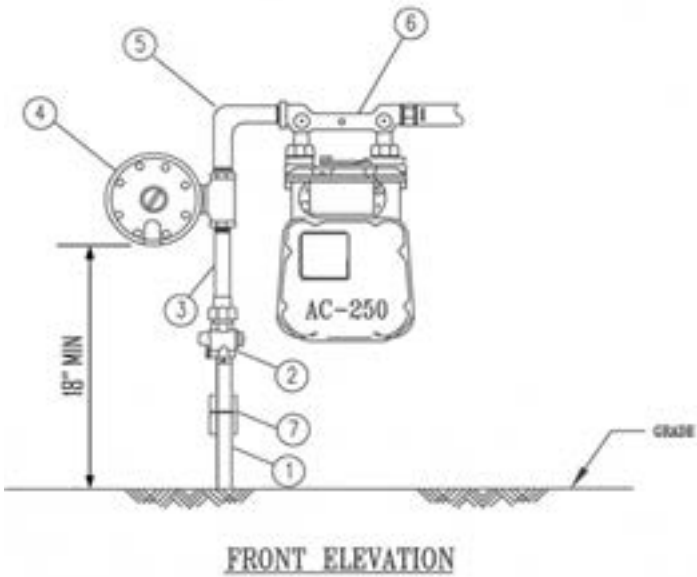
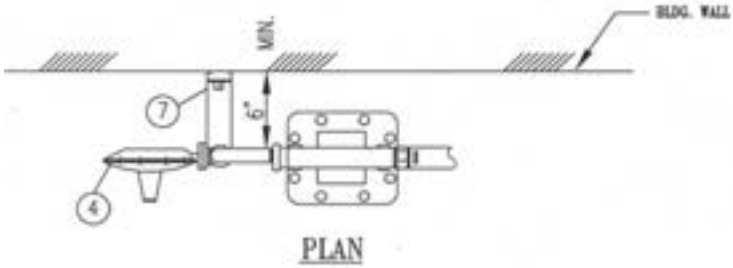

ORANGE AND ROCKLAND UTILITIES, INC.

DATE:
06/03/2002

REVISION-2
07/01/2015

DEPT.
GAS OPERATIONS

APPROVED BY:
[Signature]

REFERENCE:

STANDARD NO.:
701.1-1

APPENDIX 3

GAS STANDARDS

AL-250 RESIDENTIAL METER INSTALLATION

BILL OF MATERIALS

ITEM	QTY	SIZE	DESCRIPTION	C&S NO.
1	1	¾"	PREBENT ANODELESS RISER	3410062
2	1	¾"	LOCKING VALVE W/INSULATED UNION	3740012
3	1	¾"	PIPE NIPPLE (LENGTH TO SUIT)	
4	1	¾" x 1"	SERVICE REGULATOR	3770010
5	1	1"	METER ELBOW, 90° PRE-BENT	3330045
6	1	1"	METER BAR, INSUL. SIDE IN/SIDE OUT	3390003
7	1		METER BACKET FOR ¾" PIPE	0220019

ORANGE AND ROCKLAND UTILITIES, INC.

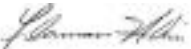
DATE: 06/03/2002	REVISION-2 07/01/2015	DEPT. GAS OPERATIONS
APPROVED BY: 	REFERENCE:	STANDARD NO.: 701.1-2

APPENDIX 3

GAS STANDARDS

AL-425 RESIDENTIAL METER INSTALLATION

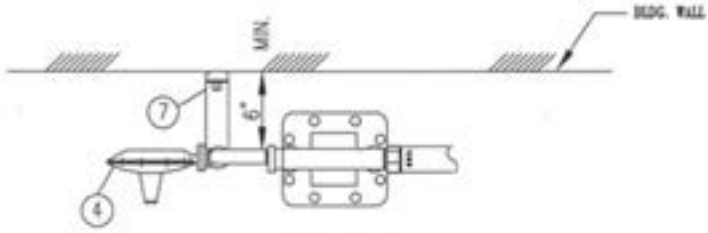

PLAN

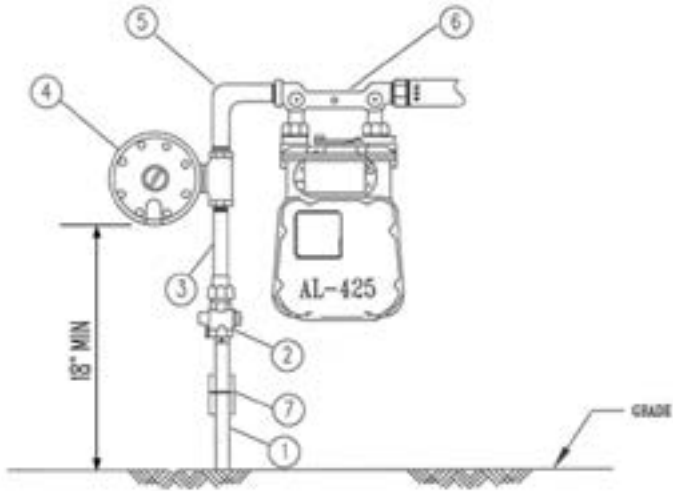

FRONT ELEVATION

ORANGE AND ROCKLAND UTILITIES, INC.

DATE:
04/20/1976

REVISION-2
07/01/2015

DEPT.
GAS OPERATIONS

APPROVED BY:
[Signature]

REFERENCE:

STANDARD NO.:
702-1

APPENDIX 3

GAS STANDARDS

AL-425 RESIDENTIAL METER INSTALLATION

BILL OF MATERIALS

ITEM	QTY	SIZE	DESCRIPTION	C&S No.
1	1	¾"	Pre-bent Riser	3410062
2	1	¾"	Locking Wing Cock w/Insulated Union	3740012
3	1	¾"	Pipe Nipple	
4	1	¾" x 1"	Service Regulator	3770010
5	2	1" x 1¼"	Reducing Elbow	3330080
6	1	1¼"	Meter Bar, Insulated, Side-in/Side-out	3390005
7	1		Meter Bracket For ¾" Pipe	0220019

ORANGE AND ROCKLAND UTILITIES, INC.

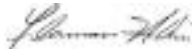
DATE: 04/20/1976	REVISION-2 07/01/2015	DEPT. GAS OPERATIONS
APPROVED BY: 	REFERENCE:	STANDARD NO.: 702-2

APPENDIX 3

GAS STANDARDS

AL-800 LOW PRESSURE METERED INSTALLATION

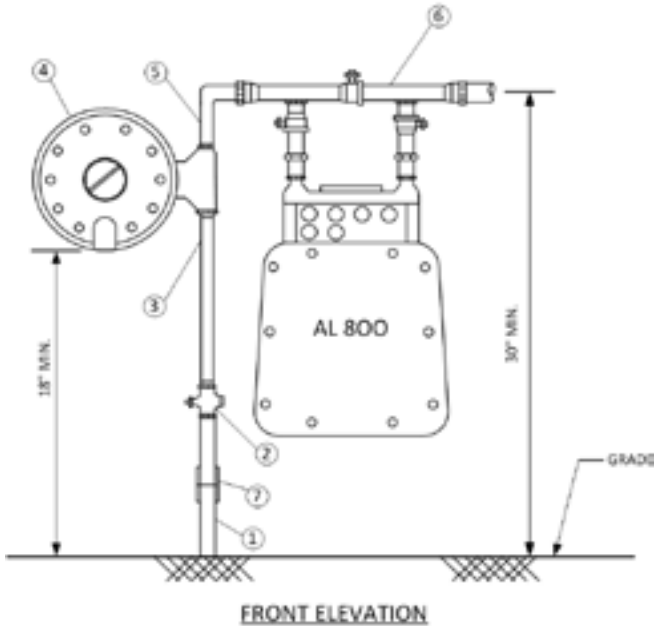
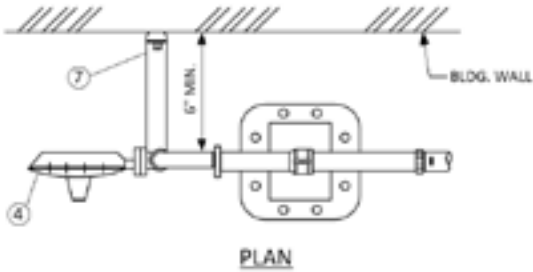

ORANGE AND ROCKLAND UTILITIES, INC.

DATE:
04/20/1976

REVISION-2
07/01/2015

DEPT.
GAS OPERATIONS

APPROVED BY:
[Signature]

REFERENCE:

STANDARD NO.:
703-1

APPENDIX 3

GAS STANDARDS

AL-800 LOW PRESSURE METERED INSTALLATION

BILL OF MATERIALS

ITEM	QTY	SIZE	DESCRIPTION	C&S No.
1	1	¾"	Pre-bent Riser	3410062
2	1	¾"	Locking Wing Cock w/Insulated Union	3740012
3	1	¾"	Pipe Nipple	
4	1	¾" x 1"	Service Regulator	3770012
5	2	1" x 1½"	Reducing Elbow	3330019
6	1	1½"	Meter Bar w/Bypass Side-in Side-out	3390018
7	1		Meter Bracket for ¾" Pipe	0220019

ORANGE AND ROCKLAND UTILITIES, INC.

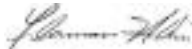
DATE: 04/20/1976	REVISION-2 07/01/2015	DEPT. GAS OPERATIONS
APPROVED BY: 	REFERENCE:	STANDARD NO.: 703-2

APPENDIX 3

GAS STANDARDS

15C-3M LP ROTARY METER INSTALLATION

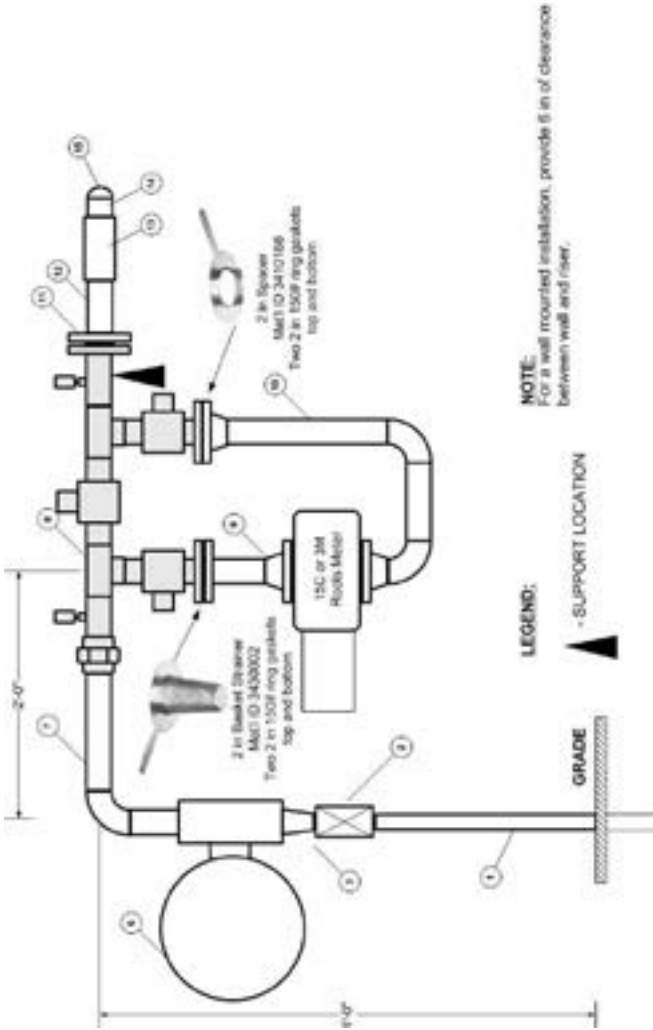

NOTE:
For a wall mounted installation, provide 6 in. of clearance between wall and riser.

LEGEND:
▲ - SUPPORT LOCATION

ORANGE AND ROCKLAND UTILITIES, INC.

DATE:
02/20/14

REVISION: 0

DEPT.
GAS OPERATIONS

APPROVED BY:
[Signature]

REFERENCE:

STANDARD NO.:
718-1

APPENDIX 3

GAS STANDARDS

15C-3M LP ROTARY METER INSTALLATION

BILL OF MATERIALS

Item	Qty	Size (In.)	Description	C&S No.
1	1	1 1/4"	Riser, 1 1/4" Stl x 1 1/4" Plx. SDR 11	3410060
2	1	1 1/4"	Locking Wing Cock, thd	3740003
3	1	1 1/4" x 2"	Swage Nipple	3300064
6	1	2"	Regulator Fisher CS8001Q	by Engr
7	1	2"	Meter Inlet Section	3380010
8	1	2"	Prefabricated Valve Manifold	3380010
9	1	2"	15C - 3M Meter Inlet Section	3380010
10	1	2"	15C - 3M Meter Outlet Section	3380010
11	1	2"	150# ANSI RF Thd Flange	3350026
12	1	2" x 6"	Steel Pipe, std wt (thread one end)	3200004
13	1	2"	Maxi-Grip Coupling insulated	3410257
14	1	2" x 8"	Steel Pipe, std wt (thread one end)	3200004
15	1	2"	Cap, MI, threaded	3410094
16	1	2"	Basket Strainer	3430002
17	1	2"	Spacer	3410188

ORANGE AND ROCKLAND UTILITIES, INC.

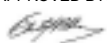
DATE: 02/20/14	REVISION: 0	DEPT. GAS OPERATIONS
APPROVED BY: 	REFERENCE:	STANDARD NO.: 718-2

APPENDIX 3

GAS STANDARDS

15C-3M HP ROTARY METER INSTALLATION

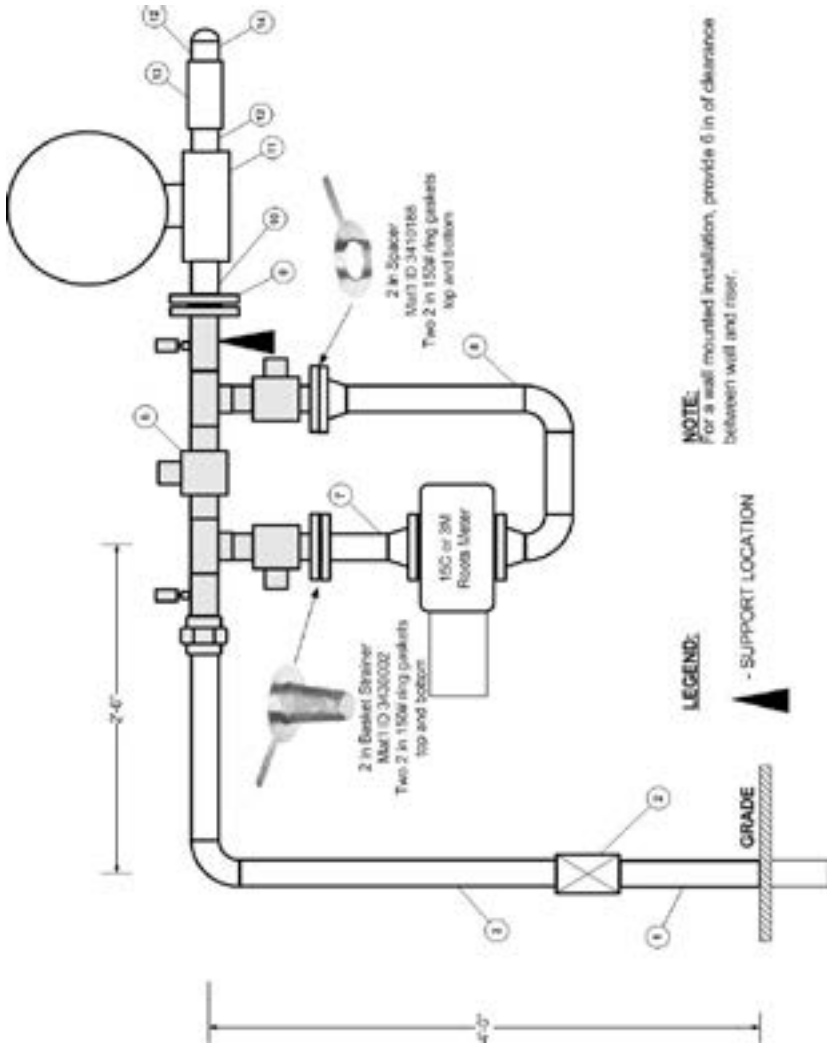

ORANGE AND ROCKLAND UTILITIES, INC.

DATE:
02/20/14

REVISION: 0

DEPT.
GAS OPERATIONS

APPROVED BY:

REFERENCE:

STANDARD NO.:
719-1

APPENDIX 3

GAS STANDARDS

15C-3M HP ROTARY METER INSTALLATION

BILL OF MATERIALS

Item	Qty	Size (In.)	Description	C&S No.
1	1	2"	Riser, 2" Stl x 2" Plx. SDR 11	3410061
2	1	2"	Locking Wing Cock, thd	3840007
3	1	2"	Meter Inlet Section	3380010
6	1	2"	Prefabricated Valve Manifold	3380010
7	1	2"	15C - 3M Meter Inlet Section	3380010
8	1	2"	15C - 3M Meter Outlet Section	3380010
9	1	2"	150# ANSI RF Thd Flange	3350026
10	1	2"	Steel Nipple, 4 in long tbe	3300088
11	1	2"	Regulator Fisher CS800IQ or S203	By Gas Engineering
12	1	2"	6 in long Steel Pipe, std wt (thread one end)	3200004
13	1	2"	Maxi-Grip Coupling insulated	3410257
14	1	2"	8 in long Steel Pipe, std wt (thread one end)	3200004
15	1	2"	Cap, MI, threaded	3410094
16	1	2"	Basket Strainer	3430002
17	1	2"	Spacer	3410188

ORANGE AND ROCKLAND UTILITIES, INC.

DATE: 02/20/14	REVISION: 0	DEPT. GAS OPERATIONS
APPROVED BY: 	REFERENCE:	STANDARD NO.: 719-2

APPENDIX 3

GAS STANDARDS

5M LP ROTARY METER INSTALLATION

BILL OF MATERIALS

Item	Qty	Size	Description	C&S No.
1	1	2"	Riser, 2" Stl x 2" Plx. SDR 11	3410061
2	1	2"	Locking Wing Cock, thd	3740007
3	2	2"	3" Nipple, tbe	3300086
5	1	2"	Regulator Fisher CS800IQ	by Engr
6	1	2"	Meter Inlet Section	3380002
7	1	2"	Prefabricated Valve Manifold	3380002
8	1	2" x 3"	5M - 7M Meter inlet Section	3380002
9	1	3" x 2"	5M Meter Outlet Section	3380002
10	1	2" x 4"	5M, 7M 11M LP Meter Outlet Section	3380002
11	1	4"	Maxi-Grip Coupling insulated	3410093
12	1	4"	5M, 7M, 11M Maxi-Grip Outlet Section	3380002
13	1	2"	Basket Strainer	3430002
14	1	2"	Spacer	3410018

ORANGE AND ROCKLAND UTILITIES, INC.

DATE: 02/20/14	REVISION: 0	DEPT. GAS OPERATIONS
APPROVED BY: 	REFERENCE:	STANDARD NO.: 720-2

APPENDIX 3

GAS STANDARDS

5M HP ROTARY METER INSTALLATION

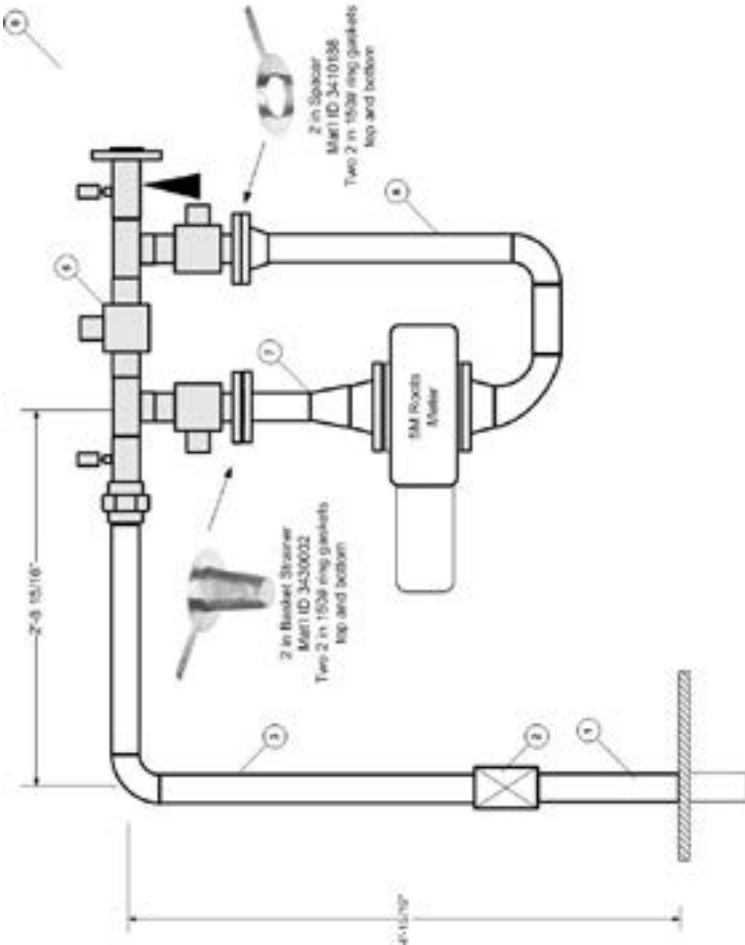

ORANGE AND ROCKLAND UTILITIES, INC.

DATE:
02/20/14

REVISION: 0

DEPT.
GAS OPERATIONS

APPROVED BY:

REFERENCE:

STANDARD NO.:

721-1

APPENDIX 3

GAS STANDARDS

5M HP ROTARY METER INSTALLATION

BILL OF MATERIALS

Item	Qty	Size	Description	C&S No.
1	1	2"	Riser, 2" Stl x 2" Plx. SDR 11	3410061
2	1	2"	Locking Wing Cock, thd	3740007
3	1	2"	Meter Inlet Section	3380002
6	1	2"	Prefabricated Valve Manifold	3380002
7	1	2" x 3"	5M - 7M Meter inlet Section	3380002
8	1	3" x 2"	5M Meter Outlet Section	3380002
9	1	2"	Regulator Fisher	by Engr
10	1	2" x 4"	5M Meter Outlet Section	3380002
11	1	4"	Maxi-Grip Coupling insulated	3410093
12	1	4"	5M, 7M, 11M Maxi-Grip Outlet Section	3380002
13	1	2"	Basket Strainer	3430002
14	1	2"	Spacer	3410018

ORANGE AND ROCKLAND UTILITIES, INC.

DATE: 02/20/14	REVISION: 0	DEPT. GAS OPERATIONS
APPROVED BY: 	REFERENCE:	STANDARD NO.: 721-2

APPENDIX 3

GAS STANDARDS

7M LP ROTARY METER INSTALLATION

BILL OF MATERIALS

Item	Qty	Size	Description	C&S No.
1	1	2"	Riser, 2" Stl x 2" Plx. SDR 11	3410061
2	1	2"	Locking Wing Cock, thd	3740007
3	2	2"	3" Nipple, tbe	3300086
5	1	2"	Regulator Fisher CS800IQ or S203	by Engr
6	1	2"	Meter Inlet Section	3380011
7	1	2"	Prefabricated Valve Manifold	3380011
8	1	2" x 4"	5M - 7M Meter inlet Section	3380011
9	1	4" x 2"	7M Meter Outlet Section	3380011
10	1	4"	5M, 7M, 11M LP Manifold Outlet Section	3380011
11	1	4"	Maxi-Grip Coupling insulated	3410093
12	1	4"	5M, 7M, 11M Maxi-Grip Outlet Section	3380011
13	1	2"	Basket Strainer	3430002
14	1	2"	Spacer	3410018

ORANGE AND ROCKLAND UTILITIES, INC.

DATE: 02/20/14	REVISION: 0	DEPT. GAS OPERATIONS
APPROVED BY: 	REFERENCE:	STANDARD NO.: 724-2

APPENDIX 3

GAS STANDARDS

7M HP ROTARY METER INSTALLATION

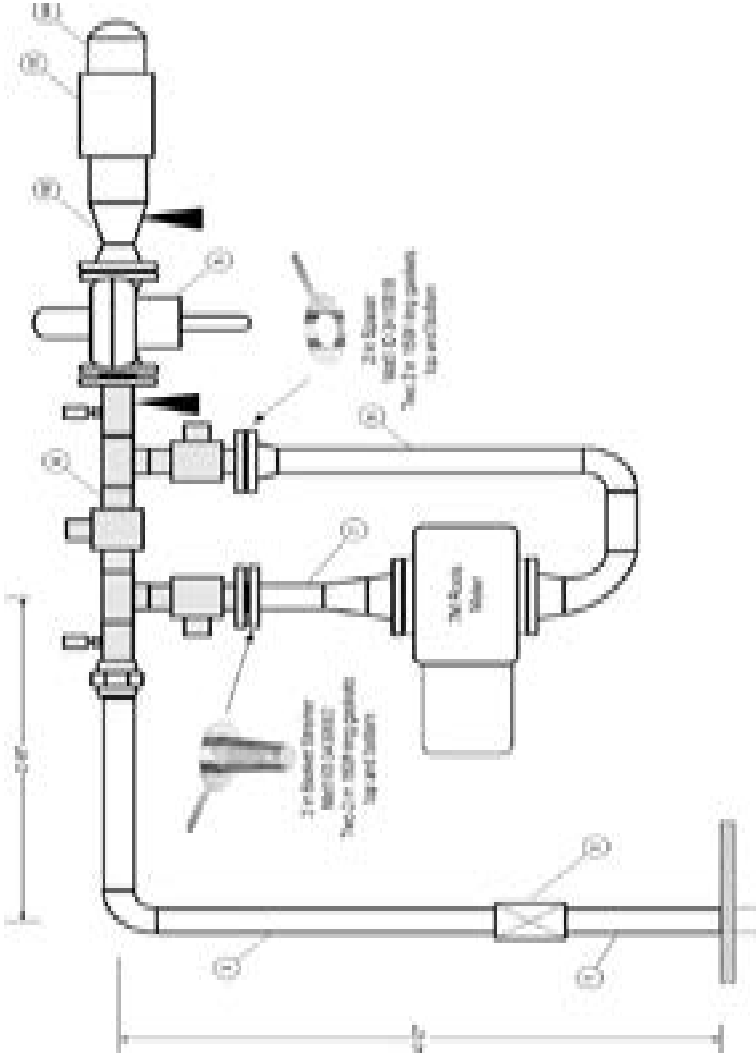

ORANGE AND ROCKLAND UTILITIES, INC.

DATE:
02/20/14

REVISION: 0

DEPT.
GAS OPERATIONS

APPROVED BY:
[Signature]

REFERENCE:

STANDARD NO.:
726-1

APPENDIX 3

GAS STANDARDS

7M HP ROTARY METER INSTALLATION

BILL OF MATERIALS

Item	Qty	Size	Description	C&S No.
1	1	2"	Riser, 2" Stl x 2" Plx. SDR 11	3410061
2	1	2"	Locking Wing Cock, thd	3740007
3	1	2"	Meter Inlet Section	3380011
6	1	2"	Prefabricated Valve Manifold	3380011
7	1	2" x 4"	5M-7M Meter inlet Section	3380011
8	1	4" x 2"	7M Meter Outlet Section	3380011
9	1	2"	Regulator Fisher	by Engr
10	1	4"	7M, 11M Manifold Outlet Section	3380011
13	1	4"	Maxi-Grip Coupling insulated	3410093
14	1	4"	5M, 7M, 11M Maxi-Grip Outlet Section	3380011
15	1	2"	Basket Strainer	3430002
16	1	2"	Spacer	3410018

ORANGE AND ROCKLAND UTILITIES, INC.

DATE: 02/20/14	REVISION: 0	DEPT. GAS OPERATIONS
APPROVED BY: 	REFERENCE:	STANDARD NO.: 726-2

APPENDIX 3

GAS STANDARDS

GAS METER BOLLARD INSTALLATION

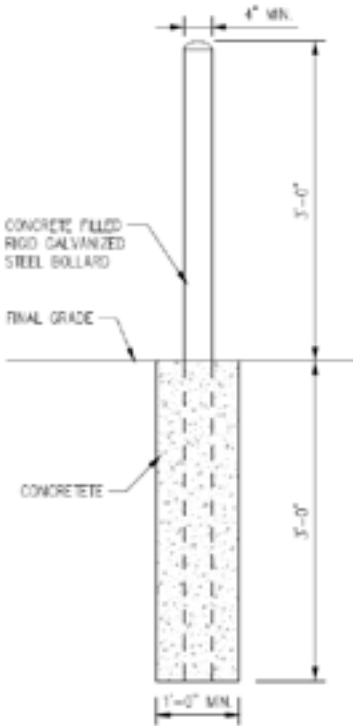

ELEVATION VIEW

NOTE:
WHERE METER IS SUSCEPTIBLE TO VEHICULAR DAMAGE,
CUSTOMER IS RESPONSIBLE FOR PROVIDING AND
INSTALLING COMPANY APPROVED BOLLARDS AS
SHOWN.

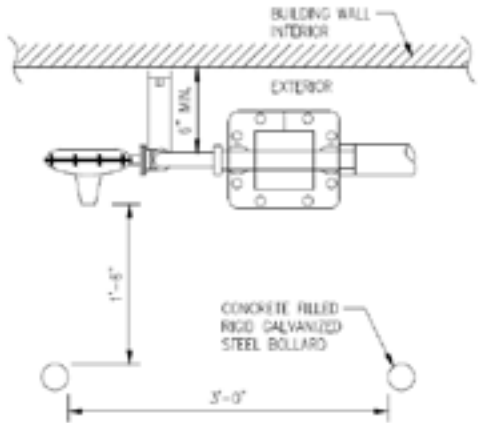

PLAN VIEW

BOLLARD DETAIL FOR GAS METER PROTECTION
NOTE: CALL 811 BEFORE YOU D.G.

ORANGE AND ROCKLAND UTILITIES, INC.

DATE:
07/01/2015

REVISION-0

DEPT.
GAS OPERATIONS

APPROVED BY:

REFERENCE:

STANDARD NO.:
731

ANSI Z223.1 TABLE II, SUPPORT PIPING

Steel Pipe, Nominal Size of Pipe (INCHES)	Spacing of Supports (FEET)	Normal Size of Tubing (INCH O.D.)	Spacing of Supports (FEET)
1/2	6	1/2	4
3/4 or 1	8	5/8 or 3/4	6
1 1/4 or Larger (HORIZONTAL)	10	7/8 or 1	8
1 1/4 or Larger (VERTICAL)	Every Floor Level		

GAS METER INSTALLATION CHECKLIST

The following checklist is in accordance with the requirements of the National Fuel Gas Code (NFGC) and Orange & Rockland.

Before you request installation or unlock the gas meter, the gas service, regulator and meter bar must be installed, with the trench backfilled to structure. In addition, a Gas Certification form, completed and signed by your contractor and building official, must be submitted to Orange & Rockland.

When calling for a gas meter

installation, please ensure the following:

- ORU gas service personnel have access to the inside of the building to perform inspections.
- You know your dwelling's total BTU load so the gas meter can be properly sized.
- Electric service has been, or will be, energized prior to the gas meter installation.

Venting:

- All flues are rigid, tight and cemented at the point of entry to masonry chimneys.
- All single-wall vent pipes have a clearance of six inches from any combustible material.
- Double wall piping (Type B) has been used when installed along the outside wall of the structure (for most commercial establishments) and has a clearance of one inch from any combustible material.
- The gas appliance vent enters the chimney above the oil appliance vent, if both share a vent.
- Heating equipment has been installed in clay tile chimneys or approved metal chimney systems.
- In the case of oil to gas conversions, the chimney – has been cleaned. If the chimney is not lined, a flue liner has been installed. Proof of chimney inspection and a cleaning certificate is required.
- Gas appliances are not vented with wood burning appliances.
- A minimum of one gas appliance has been installed and is ready to operate.

Fuel Lines:

- All lines have doped fittings and are supported or strapped (inside, outside and on rooftops) every six feet.
- Water heaters, boilers and furnaces have drip legs, and flexible pipe connectors have not been used.
- Every appliance has a separate, easily accessible shut-off valve within six feet of the appliance and in the same room as the appliance.
- The shut-off valve for a gas range is located within the same room as the appliance.
- All fuel line unions are located on the appliance side of shut-off valves.

- Fuel lines have been connected to the meter bar.
- On multiple-metered installations, the meter bars have been permanently marked with corresponding unit/apartment numbers.
- The units/apartments themselves have been clearly marked.
- Fuel lines have been air tested for leaks.
- Fuel lines must be sleeved when penetrating any exterior wall or any interior masonry wall.
- Flexible gas fuel lines have been installed within manufacturer and NFGC specifications using approved pipe fittings and adaptors. Exterior wall penetration to the outside meter bar has been made with black iron pipe.

Appliance Installations:

- All appliances have been installed in accordance with manufacturer and NFGC specifications. These appliances have been made accessible.
- A utility room or closet containing a gas dryer has a fully louvered door or one-inch space above the finished floor.
- Vented appliances have not been installed in a closed room (e.g. bedroom, bathroom), unless they draw fresh air from outside the sealed unit.
- The burner portion of any appliance installed in a garage is at least 18 inches above the floor, unless the unit is manufacturer- and NFGC-approved for direct floor installation.
- The appliance is protected from vehicular or physical damage with the installation of bollards or posts imbedded into the concrete floor.
- All utility rooms that have a boiler, furnace or water heater have provisions for makeup air in accordance with local building codes.
- Where roof access is over 14 feet, permanent stairs or hatchways in the interior of the building have been provided to ensure access to heating systems installed on rooftops.

Note: An initial inspection by the Company will be performed at no charge. A fee will be charged for subsequent inspections, with payment to be made, by check, prior to each repeat inspection.



UNDERGROUND FUEL PIPING BEYOND METER

CUSTOMER: PLEASE HAVE YOUR CONTRACTOR FILL OUT AND SIGN THIS FORM, AND ATTACH COMPANY WILL SCHEDULE A PRESSURE TEST AND INSPECTION WITH YOU.

Customer Name: _____

Phone: _____

Account Number: _____
(if known)

Fuel Line: (circle one below)

Plastic / Steel / K-Copper / CSST

Size: _____

Length: _____

Total (BTU) Connected Load: _____

Fuel Line End Use: _____

Current Meter Size: (circle one below)

AL-250 / AL-400 / AL-425 / AL-800 / AL-1400 / Other _____

Test Pressure Set At: _____ (PSI)

Municipality: _____

Address: _____ Side of Street (circle one below)
N / S / E / W

Fill in the Nearest Pole Number: _____ Example: 60851
41118

Fill in the Nearest Underground Electric Transformer Box Number: _____ Example: 49
59

Company Name: _____ Phone: _____

Qualified Signature: _____ Date: _____

INSPECTOR'S INFORMATION

Date: _____ Inspector: _____

Air Test: _____ psi _____ min.

Pipe to soil: _____ mV

Passed or Rejected

Inspection Date: _____

Comments: _____

Meter Size Needed: _____





If you damage or pull a gas facility, or you smell gas:

- Keep all persons away from the area
- Eliminate sources of ignition
- Call 911 or our Gas Emergency Hotline at 1-800-533-LEAK (5325)